

Anpa arquitectura,  
Barcelona, Spain





## **DOWNITO® 90**

TRIMLESS



# DOWNITO®90

TRIMLESS

- LED downlight for accent lighting
- Smart reflector: active + passive (paintable)
- Multi-power downlight, from 8 W to 19 W
- Luminous flux range from 600 lm to 1800 lm
- Luminaire efficiency 120 lm/W
- 3 beam angles: 30°, 55° and 105°
- Excellent integration with trimless models
- Special LEDs to improve the food and retail colors
- Accessories available: diffuser clear and opal

- Downlight LED para iluminación de acento
- Reflector inteligente: activo + pasivo (pintable)
- Downlight multi-power, de 8 W a 19 W
- Flujos lumínicos de 600 lm a 1800 lm
- Eficiencia de la luminaria 120 lm/W
- 3 ángulos de apertura: 30°, 55° y 105°
- Integración perfecta con los modelos trimless
- LEDs especiales para potenciar los colores en alimentación y retail
- Accesorios disponibles: difusor transparente y opal

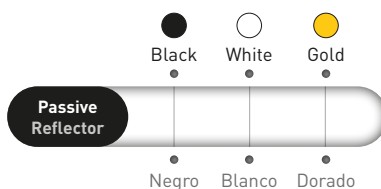
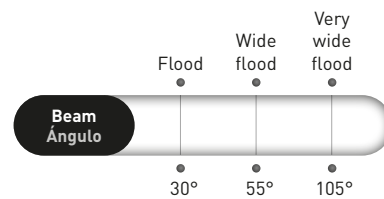
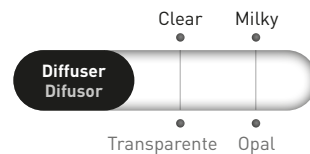
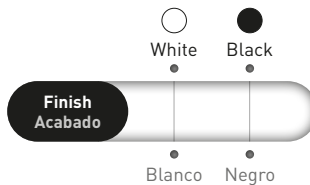
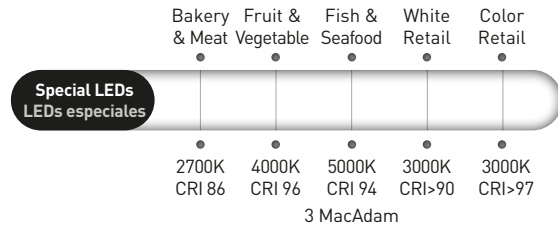
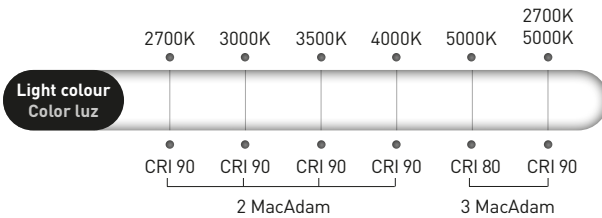
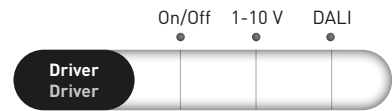
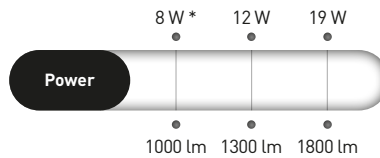
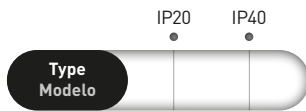

\* 8W only available with On/Off Control.  
8W sólo disponible con control On/Off.

The standard IP20 version is delivered with chromed reflector. Driver not included.  
La versión estándar IP20 se suministra con reflector cromado. Driver no incluido.

The standard IP40 version is delivered with clear diffuser and chromed reflector. Driver not included.  
La versión estándar IP40 se suministra con difusor transparente y reflector cromado. Driver no incluido.

**SPECIFICATIONS**  
**CARACTERÍSTICAS**

UGR <19	IP20 IP40		on/off	DALI	1-10V	Driver Not Included	AL Housing	Ta min -20°C -4°F Ta max +50°C max +122°F	
------------	--------------	--	--------	------	-------	---------------------------	---------------	--	--

Downito® 90 TRIMLESS						
Measures	Ø90 x 95 mm					
Weight	0,7 kg					
8 W (250 mA)						
Color temperatures	<b>2700K - CRI 90</b>	<b>3000K - CRI 90</b>	<b>3500K - CRI 90</b>	<b>4000K - CRI 90</b>	<b>5000K - CRI 80</b>	<b>2700K-5000K - CRI 90</b>
Lumens output	30° - 690 lm 55° - 655 lm 105° - 615 lm	30° - 742 lm 55° - 705 lm 105° - 662 lm	30° - 776 lm 55° - 738 lm 105° - 691 lm	30° - 809 lm 55° - 770 lm 105° - 720 lm	30° - 985 lm 55° - 940 lm 105° - 880 lm	30° - 587-675 lm 55° - 556-641 lm 105° - 522-602 lm
Luminaire efficiency	77 to 86 lm/W	83 to 93 lm/W	86 to 97 lm/W	90 to 101 lm/W	110 to 123 lm/W	65 to 84 lm/W
12 W (350 mA)						
Color temperatures	<b>2700K - CRI 90</b>	<b>3000K - CRI 90</b>	<b>3500K - CRI 90</b>	<b>4000K - CRI 90</b>	<b>5000K - CRI 80</b>	<b>2700K-5000K - CRI 90</b>
Lumens output	30° - 920 lm 55° - 875 lm 105° - 819 lm	30° - 960 lm 55° - 914 lm 105° - 855 lm	30° - 1070 lm 55° - 960 lm 105° - 897 lm	30° - 1054 lm 55° - 1003 lm 105° - 938 lm	30° - 1287 lm 55° - 1225 lm 105° - 1145 lm	30° - 782-900 lm 55° - 744-855 lm 105° - 696-802 lm
Luminaire efficiency	68 to 76 lm/W	71 to 80 lm/W	75 to 89 lm/W	78 to 88 lm/W	95 to 107 lm/W	58 to 75 lm/W
19 W (500 mA)						
Color temperatures	<b>2700K - CRI 90</b>	<b>3000K - CRI 90</b>	<b>3500K - CRI 90</b>	<b>4000K - CRI 90</b>	<b>5000K - CRI 80</b>	<b>2700K-5000K - CRI 90</b>
Lumens output	30° - 1311 lm 55° - 1248 lm 105° - 1168 lm	30° - 1370 lm 55° - 1303 lm 105° - 1221 lm	30° - 1428 lm 55° - 1356 lm 105° - 1270 lm	30° - 1482 lm 55° - 1410 lm 105° - 1320 lm	30° - 1826 lm 55° - 1738 lm 105° - 1650 lm	30° - 1015-1282 lm 55° - 1060-1219 lm 105° - 992-1140 lm
Luminaire efficiency	67 to 69 lm/W	64 to 72 lm/W	67 to 75 lm/W	70 to 78 lm/W	87 to 96 lm/W	52 to 67 lm/W

Downito® 90 TRIMLESS Special LEDs					
Measures	Ø90 x 95 mm				
Weight	0,7 kg				
12 W (350 mA)					
Color temperatures	<b>Bakery &amp; Meat 2700K - CRI 86</b>	<b>Fruit &amp; Vegetable 4000K - CRI 96</b>	<b>Fish &amp; Seafood 5000K - CRI 94</b>	<b>White Retail 3000K - CRI &gt; 90</b>	<b>Color Retail 3000K - CRI &gt; 97</b>
Lumens output	30° - 644 lm 55° - 613 lm 105° - 574 lm	30° - 816 lm 55° - 777 lm 105° - 727 lm	30° - 835 lm 55° - 795 lm 105° - 744 lm	30° - 912 lm 55° - 869 lm 105° - 813 lm	30° - 864 lm 55° - 821 lm 105° - 770 lm
Luminaire efficiency	48 to 54 lm/W	61 to 68 lm/W	62 to 70 lm/W	68 to 76 lm/W	64 to 72 lm/W
19 W (500 mA)					
Color temperatures	<b>Bakery &amp; Meat 2700K - CRI 86</b>	<b>Fruit &amp; Vegetable 4000K - CRI 96</b>	<b>Fish &amp; Seafood 5000K - CRI 94</b>	<b>White Retail 3000K - CRI &gt; 90</b>	<b>Color Retail 3000K - CRI &gt; 97</b>
Lumens output	30° - 917 lm 55° - 873 lm 105° - 817 lm	30° - 1165 lm 55° - 1108 lm 105° - 1038 lm	30° - 1192 lm 55° - 1133 lm 105° - 1062 lm	30° - 1302 lm 55° - 1238 lm 105° - 1160 lm	30° - 1233 lm 55° - 1173 lm 105° - 1100 lm
Luminaire efficiency	43 to 48 lm/W	55 to 61 lm/W	56 to 63 lm/W	61 to 69 lm/W	58 to 65 lm/W

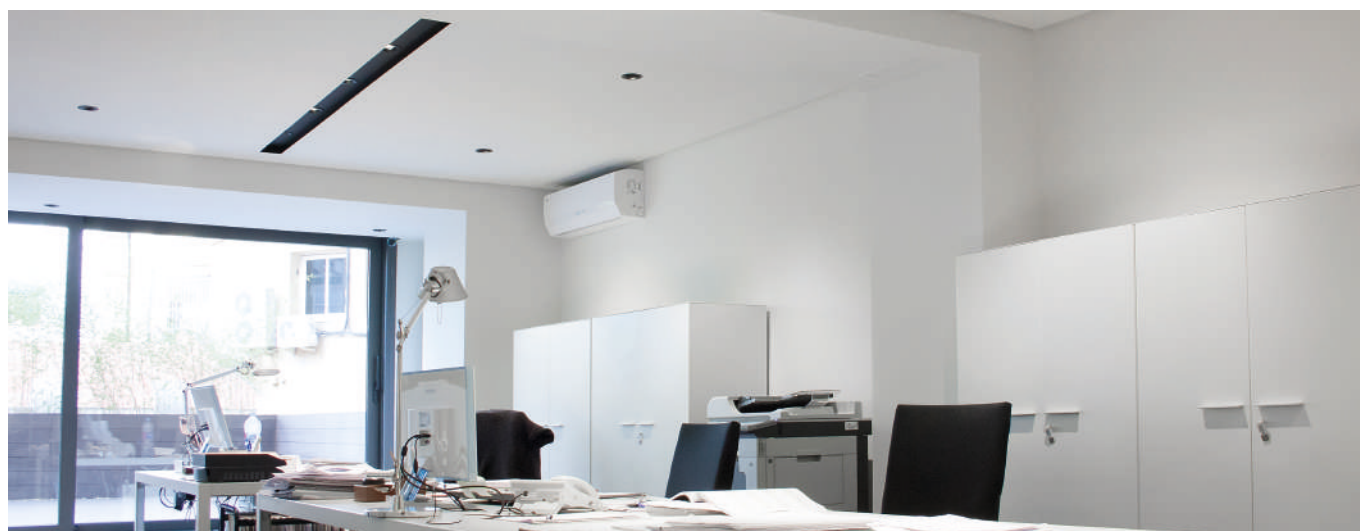

Color temperature conform to **ANSI C78.377A**.  
Lumens measurement conform to **LM-79-08**.  
Lumens maintenance conform to **LM-80-08**.

Temperatura de color según normativa **ANSI C78.377A**.  
Medición lumens según normativa **LM-79-08**.  
Mantenimiento lumens según normativa **LM-80-08**.

Anpa arquitectura,  
Barcelona, Spain



# DOWNITO® 90

TRIMLESS

## MEASURES MEDIDAS

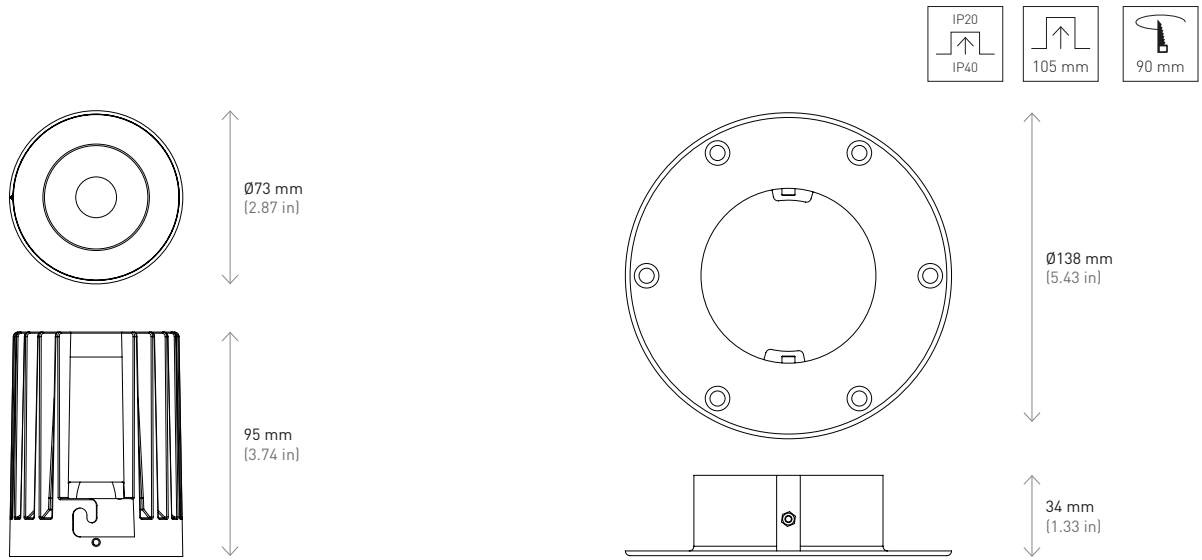

## FINISHES ACABADOS

In order to satisfy all our customers, two different finishes are available: white and black.  
Con el fin de satisfacer las necesidades de nuestros clientes, está disponible en dos acabados: blanco y negro.



White.  
Blanco.

(RAL 9003)



Black.  
Negro.

(RAL 9011)

## INSTALLATION INSTALACIÓN

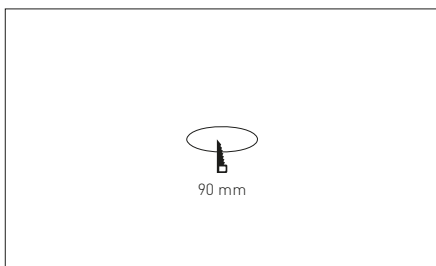

Make the hole  
Efectúe el orificio

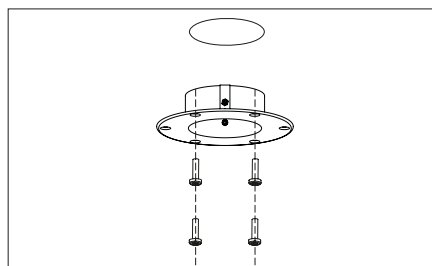

Fix the plasterboard recessed box with the screws  
Fije el cajetín de empotrar con los tornillos

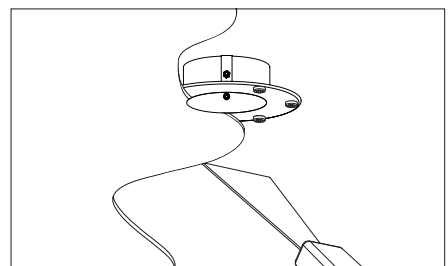

Plane with plaster  
Enrasar con yeso

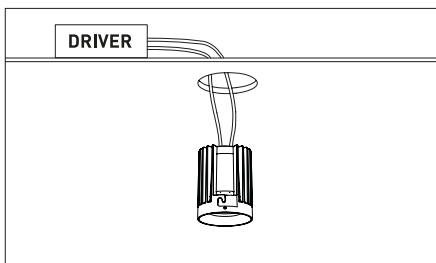

Connect the luminaire to the power supply  
Conecte la luminaria a la fuente de alimentación

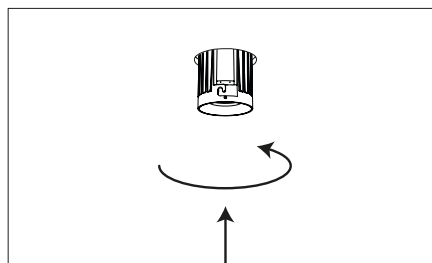

Place up and spind around  
Subir y girar

**DETAILS**  
**DETALLES**

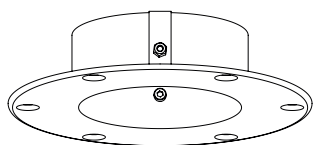

Plasterboard  
recessing frame Plasterboard

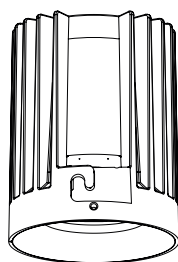

Trimless  
body



COB



COB holder

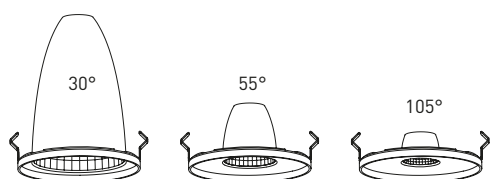

Active reflector  
(Engineering by Bartenbach)



Diffuser (IP40)  
Clear and Milky

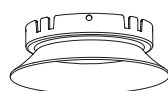

Passive reflector (paintable)



**DETAILS**  
**DETALLES**

Different finishes for the passive reflector are available: white, black and gold.  
Se pueden escoger diferentes acabados para el reflector pasivo: blanco, negro y dorado.



# DOWNITO® 90

TRIMLESS

## LIGHT DISTRIBUTION CURVES FOTOMETRÍAS

### Downito® 90 Trimless

3500K 30°

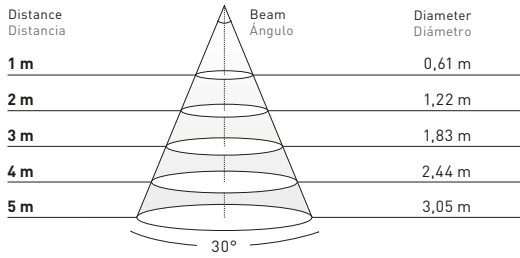

	8 W	12 W	19 W
1 m	1.648 lux	2.182 lux	2.870 lux
2 m	412 lux	546 lux	718 lux
3 m	183 lux	242 lux	319 lux
4 m	103 lux	136 lux	179 lux
5 m	66 lux	87 lux	115 lux

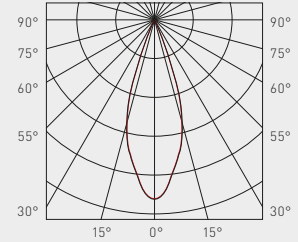

### Downito® 90 Trimless

3500K 55°

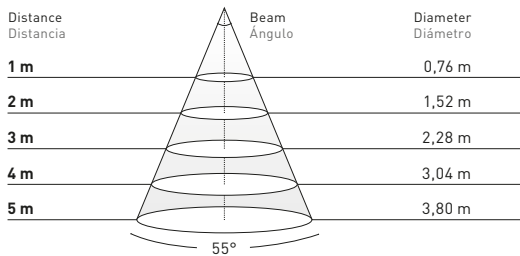

	8 W	12 W	19 W
1 m	742 lux	982 lux	1.292 lux
2 m	185 lux	245 lux	323 lux
3 m	82 lux	109 lux	144 lux
4 m	46 lux	61 lux	81 lux
5 m	30 lux	39 lux	52 lux

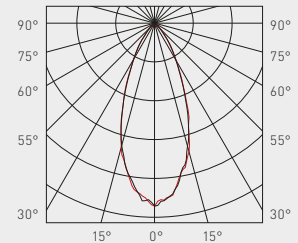

### Downito® 90 Trimless

3500K 105°

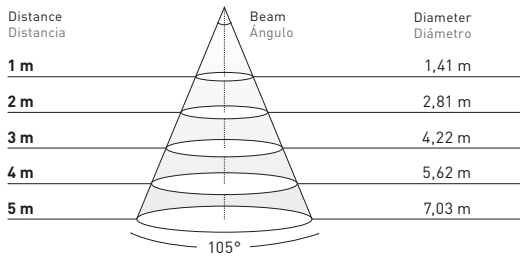

	8 W	12 W	19 W
1 m	316 lux	421 lux	554 lux
2 m	79 lux	105 lux	138 lux
3 m	35 lux	47 lux	62 lux
4 m	20 lux	26 lux	35 lux
5 m	13 lux	17 lux	22 lux

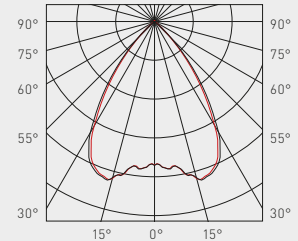

Data calculated with **Downito® 90 (3500K)**.  
Lumen measurement complies with **UNE-EN 13032 / IES LM-79-08** testing procedures.  
Light distribution curves are available at [www.mclight.com](http://www.mclight.com).  
Due to continuous improvements and innovations, specifications may change without notice.

Datos calculados con **Downito® 90 (3500K)**.  
Ensayado bajo las especificaciones de la norma **UNE-EN 13032 / IES LM-79-08**.  
Fotometrías disponibles en [www.mclight.com](http://www.mclight.com).  
Debido a las continuas mejoras e innovaciones, las especificaciones pueden cambiar sin previo aviso.

## CONNECTIONS CONEXIONES

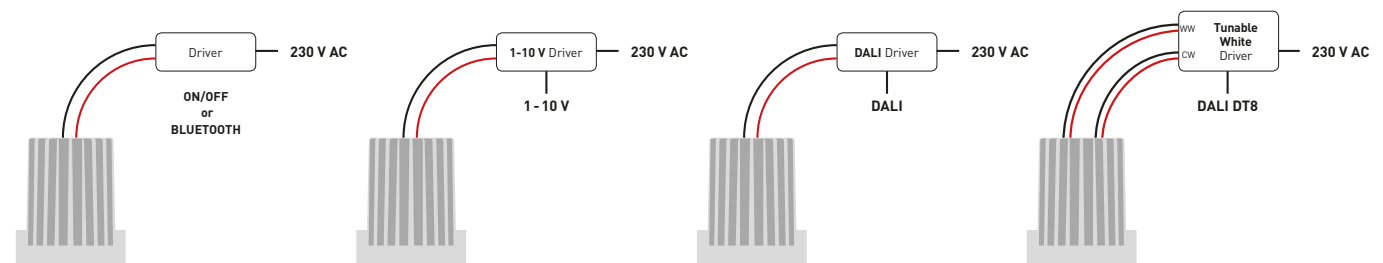

**REFERENCES**  
**REFERENCIAS**

**7111** X X X /XX/XX

**COLOR COLOR**

/90/2K7	2700K
/90/3K	3000K
/90/3K5	3500K
/90/4K	4000K
/80/5K	5000K
/2K7-5K	Tunable white
/86/2K7	Bakery & Meat
/96/4K	Fruit & Vegetable
/94/5K	Fish & Seafood
/90/3KX	White Retail
/97/3K	Color Retail

**BEAM ÁNGULO**

0	30°
1	55°
2	105°

**FINISHES ACABADOS**

6	Trimless Black	Trimless Negro
7	Trimless White	Trimless Blanco

**TYPE MODELO**

0	IP20
1	IP40

**OPTIONS**  
**OPCIONES**

The standard version is delivered with:  
clear diffuser and chrome reflector.

La versión estándar se suministra con:  
difusor transparente y reflector pasivo cromado.

**DIFFUSER DIFUSOR (IP40)**

Clear	Transparente	<b>(Standard)</b>
Milky	Opal	

**PASSIVE REFLECTOR REFLECTOR PASIVO**

Chrome	Cromado	<b>(Standard)</b>
Black	Negro	
White	Blanco	
Gold	Dorado	

**PLASTERBOARD RECESSING FRAME**  
**CAJETÍN DE EMPOTRAR TRIMLESS**



**7111009/C02** Plasterboard recessing frame  
Cajetín de empotrar trimless

**DRIVERS REFERENCES**  
**REFERENCIAS DRIVERS**



Drivers 350mA		
3091007	On-Off Led Driver 350mA 3.5W-15W	Led Driver 350mA 3.5W-15W On-Off
3090771	1-10V Led Driver 350mA 12W	Led Driver 350mA 12W 1-10V
Drivers 500mA		
3090773	On-Off Led Driver 500mA 16W	Led Driver 500mA 16W On-Off
3090774	1-10V Led Driver 500mA 18W	Led Driver 500mA 18W 1-10V
Drivers multi-power		
3090794	On-Off Led Driver Multi-power 22W	Led Driver Multi-power 22W On-Off
3090701	1-10V Led Driver Multi-power 0W-20W	Led Driver Multi-power 0W-20W 1-10V
3090702	DALI Led Driver Multi-power 0W-32W	Led Driver Multi-power 0W-32W DALI
Drivers multi-power Bluetooth		
7150930	Casambi Led Driver Multi-power 300mA-1050mA 38W	Led Driver Multi-power 300mA-1050mA 38W Casambi
7150931	Zigbee Led Driver Multi-power 300mA-1050mA 38W	Led Driver Multi-power 300mA-1050mA 38W Zigbee
Driver tunable white		
3091016	DALI DT8 Led Driver 500mA 35W Tunable White	Led Driver 500mA 35W Tunable White DALI DT8

**MULTI-POWER DRIVER CONNECTIONS TABLE**  
**TABLA DE CONEXIONES DRIVER MULTI-POWER**

		250 mA	350 mA	500 mA
3090794	On/off	8 W	12 W	19 W
3090701	1-10 V	-	12 W	19 W
3090702	DALI	-	12 W	19 W



DIP switch

To control the luminaires via Bluetooth see page 312  
Para controlar las luminarias via Bluetooth consultar página 312